



Tonnellerie
ROUSSEAU
In Burgundy since 1954



PROFESSIONAL CATALOGUE



© A. Finlatre



Good morning everyone,

We are pleased to know you are now reading the pages of our new catalog and we are happy to share with you the motivations that animate us every day. Just like the profession you practice, cooperage is a human profession, of excellence, of passion, of precision, of tradition and of history, it is quite a craft, some even say it is an art meant to be shared.

We encourage you to discover through these pages our history, our profession, or rather our professions, coopers and casks/tanks builders, both intimately linked. At the Tonnellerie Rousseau, one does not work without the other and this complementarity lasted for generations. Each activity benefits from the expertise, know-how, experience of the other and vice versa. It is a true richness and an exceptional openness.

Why build a barrel, why build a tank or a cask, with what oak sources, for what need, what objective, what wine? These are all questions that we strive to answer every day, in close collaboration with you, for your wines. Our mission: to elevate your wines, to create pleasure, with respect for Men, Nature and History. That's what drives us every day! Refining the oak selection and seasoning, toasting it, transforming it, magnifying it, following up on your vessels' life with you, what a pleasure! In this catalogue you will discover our history, our products, our services, our areas of expertise, and our will to build with you the future.

There is no miracle recipe in our craft, we all have to work and deal humbly with the material, which we select with the greatest accuracy and which is entrusted to us. Know that we will spare no effort to bring you answers, satisfaction, a dedicated service, a strong relationship, and that the whole team will remain available and will give the best of themselves to meet your objectives, in all transparency and humility. We wish you a good reading and hope to welcome you soon in our workshops in action.

At your service,
See you soon,



Frédéric & Jean-Christophe Rousseau

CONTENTS

INTRODUCTION

Our history	4
Our know-how	5
The best of French oak	6
Our expertise in your cellar	7

BARRELS

The cooperage workshop	10
Aromatic profiles summary	12
Expert range	14
Traditional range	18
Confidential series	22
Exceptional series	26
Outside France series	30

COOPERAGE APPENDIX

Options & customization of barrels	34
Barrels dimensions	35
Barrels stands	36
Barrel users manual on maintenance and storage	37

CASKS & VATS

The large format workshop	40
Research and development, new products	42
Customization: Shapes	44
Customization: Dimensions & volumes	46
Customization: Accessories	47
Customization: Finishing	48
Customization: Turnkey	50
Turnkey large formats	52

LARGE FORMATS APPENDIX

Large Format users manual on maintenance	56
Everywhere in France & internationally	58

OUR HISTORY

It all started in 1954 with Julien Rousseau. At that time, he founded the Tonnellerie Rousseau to focus on large formats. The company quickly became a family business: his 2 sons, Jean-Marie and Guy, joined the ranks of Rousseau coopers in the 1970s and 1980s. In 1990, Jean-Marie Rousseau took over the management of the company, with the support of his wife Nicole, who joined the company to manage the administrative and financial part. The next generation arrived in the 2000s! Jean-Christophe Rousseau in 2001: he joined the family business as a "foudrier" (cooper specialized in large vessels), once graduated from a cooperage trade school in Cognac. He became director of the large vessel workshop in 2007.

After studying business management and starting in finance and trade, Frédéric Rousseau joined the company in 2004 as sales director.

"We fell into the barrel business when we were little!"

Frédéric & Jean-Christophe
ROUSSEAU

This complementarity between the two brothers is the strength of this 3rd generation, officially at the helm of Tonnellerie Rousseau since January 1, 2021. It is their turn to contribute to the family business which will soon be celebrating its 70th anniversary. A great story of transmission that Tonnellerie Rousseau shares with its customers: "We have customers who have followed us from the very beginning. They also passed on their estate from generation to generation and today we work with the grandchildren of our grandfather's clients," says Frédéric. ●



© Didier Hugue

OUR EXPERTISE

Tonnellerie Rousseau is a family. But it is also the mastery of an ancestral "savoir-faire", imagined by our Gallic predecessors. The whole team consisting of coopers, salespeople and executives is committed to continue and improve on this heritage. Tonnellerie Rousseau, indomitable Gauls? (reference to the Asterix comic books) And why not?

Composed of a team of more than 40 people with an average age of only 35, Tonnellerie Rousseau emphasizes the transmission of its cooper and large-format expertise.

"When I arrived, I did not have any particular knowledge of the job of large format manufacturer, says Olivier, cooper with Rousseau since 2001. Tonnellerie Rousseau took me on a 3-week trial basis. Then the 3 weeks turned into 20 years!" Trained directly in the workshop, Olivier is today "Meilleur Ouvrier de France" (Best Craftsmen of France)". The aspiration of the new generation: to pass on cooperage expertise while bringing modernity and innovation in a conti-

nuous search for excellence to enhance the great wines of the world and bring pleasure to the wine lover.

Today, we are proud to be working in two professions. The Cooperage and the large format manufacturing are intimately connected with each other and each metier features unique characteristics in terms of material, mechanization, approach and oenology. At the Tonnellerie Rousseau, one does not work without the other and each brings its expertise and methods to the other, an essential and natural combination for us.

This Tonnellerie/Foudrerie dual activity feeds our daily work, our thoughts and evolutions, human and technical.

The objectives: satisfaction, respect for the coopers and the material, quality, performance, safety and reduction of physical stress (MSD, dust...). See pages 40 - 41: Large Formats Workshop ●

"More than a job, it is an artistic work that we have the privilege of exercising"

Laurent, cooper at Rousseau since 1996



All in all, there are no less than 11 Meilleurs Ouvriers de France (trained at La Tonnellerie Rousseau).

In the Rousseau family, I ask...

THE GRANDFATHER graduated MOF in 2004

UNCLE graduated MOF in 2007

DAD graduated MOF in 2007

THE SON graduated MOF in 2007

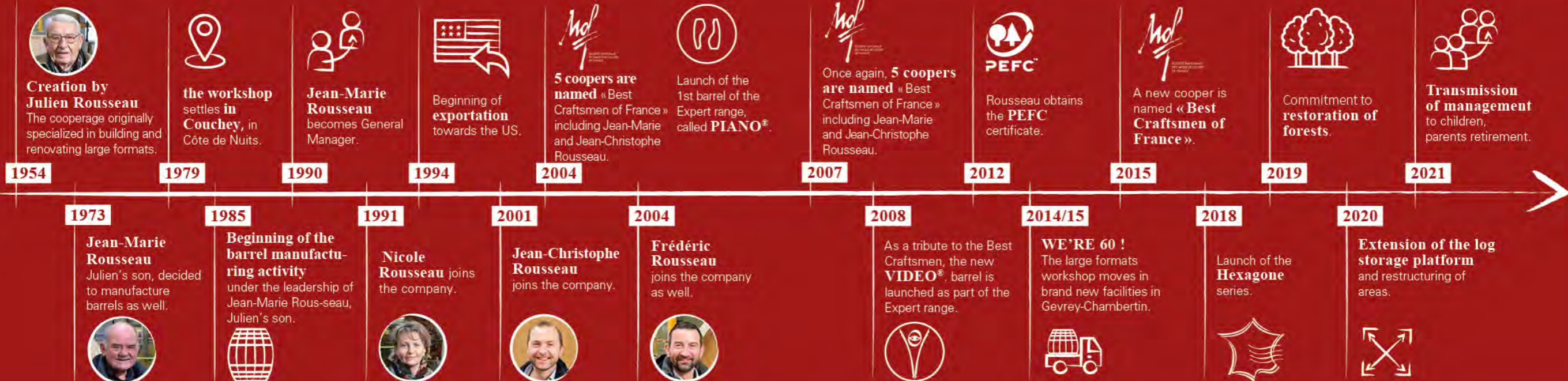

THE BEST OF FRENCH OAK

Oak is the starting point of our profession of cooper and cask-manufacturer. To create the best barrels, the best casks or even the best vats, Tonnellerie Rousseau strives to select its oak staves with the greatest care, while respecting the material and the nature.



Trusted Supplier Partnership

We work exclusively with partners, stave mills and loggers, who share our values. We turn to companies with the same size as Tonnellerie Rousseau, often also passed down from father to son. But also and above all suppliers who have an irreproachable qualitative approach and respect the material and the people who make up their teams. Essential criteria in order to develop a partnership of trust.



Material traceability

Depending on the forest from which the oak wood is taken, our barrels, our casks or our vats will have different contributions to your wines. The provenance is therefore very important. Tonnellerie Rousseau has had the PEFC certificate since 2012. This label guarantees enhanced traceability of the wood used. Coming from sustainably managed French forests and controlled sources, the oak used by our cooperage is carefully selected for its quality and its use with the upmost respect for environmental balance.



Seasoning

It is in the timber yard of Tonnellerie Rousseau, in Pouilly-sur-Saône (21), that all of the raw material is delivered, sorted, watered, matured and air dried. Before passing into the hands of the coopers and cask manufacturers at the manufacturing workshop, the wood is therefore refined thanks to natural elements for 2

to 5 years in this open-air maturation park. An essential step to enhance the impact that the barrel, the cask or the vat will have on your wine.



Sustainable Sourcing and Recycling

For several years, Tonnellerie Rousseau has been working to optimize the use of natural resources and reduce its environmental impact. When we purchase the raw material, we make sure to consume it entirely: 1m³ purchased for 1m³ consumed. Our waste materials are recycled in firewood for our barrels, but also in other sectors of activity such as energy. Nothing is lost, everything is transformed!



Reforestation

Since 2019, Tonnellerie Rousseau has participated in a regeneration plan for French forests with Reforest'Action. Each year, we finance the planting of 2,000 trees on plots such as the forest of Ferté Vidame (28), Broindon (21) or even Beaumont-la-Ferrière (58). A commitment that is close to our hearts since we work closely with nature.

OUR EXPERTISE IN YOUR CELLAR

For more than 60 years, Tonnellerie Rousseau has put its experience and expertise at the service of great wines. Our objective? May the aromatic and mechanical quality of our barrels, casks and vats be up to your wines. Our reason for being? Respect and value your wine to help create pleasure and emotion.



A Close support

> Our technical sales rep assists you in the field to offer you barrels-tanks-casks that are always more suited to your wines programs needs. At Tonnellerie Rousseau, you have one dedicated sales rep or agent.

> We are constantly on **the lookout for new developments:** oak, toasting, fittings... What is our main objective? Getting ahead of your needs.

> Our key words are: **adjustment to your various wines ageing needs, customization of our products** to meet your sensory and fermentation/maturation goals, respect and attentive listening to our customers above all. Tonnellerie Rousseau is present on several continents!



A sense of integrated service

> We ensure the **delivery and installation of our products in the cellar.** Even the most voluminous! And even in the most difficult to access cellars! When access or space constraints prevent conventional delivery, we regularly perform disassembly and reassembly of large containers in the cellar.



> Our work doesn't end with delivery. It is fundamental for us to perform a solid after-sales service in providing gaskets, minor repairs and fittings replacement. **Beyond the after-sales service, it is a real partnership & relationship we establish with our customers.**

> Do not hesitate to consult with us for **these after-sales issues** as well as financing needs.



Controlled technical and microbiological risks

> **No chemicals**, even those approved by the wine industry, are allowed in the manufacture of our products.

> **All the woods used are analyzed in our workshops** to ensure the absence of unwanted molecules such as TCA / TCP (responsible for corky, musty, corky tastes).

> Several times a year, **we check the quality of the air and water in our workshops** and in our lumber yard to ensure that there is no contamination by organochlorines.

> On each of our products, **we carry out a strict leak test.** No barrel, cask or vat leaves our workshops without having undergone a series of tests.



COOPERAGE

THE COUCHEY COOPERAGE WORKSHOP



In the early 1980s, the Rousseau family saw the potential of the production of 228L barrels. To keep up with the changing needs of winegrowers, the original large french format activity evolved on the production of smaller containers, thus are born the first Burgundian barrels of 228L. The beginning of a long series!



Since its creation in 1954, Tonnellerie Rousseau has always been anchored in the heart of the Côte de Nuits. The idea was to be as close as possible to the winegrowers. Established in Couchey from 1979, the company is still present in this village south of Dijon to this day. Today, the historic Couchey site houses the barrel-making workshop, as well as the head office and administration of Tonnellerie Rousseau. The large vessel workshop has taken up residence in a new building in Gevrey-Chambertin.



In Couchey's workshop, our coopers manufacture barrels with capacities ranging from 114 to 600 litres. Divided into several ranges, each with its specific characteristics (oak, grain, braser heaters), Rousseau barrels can meet various technical needs in terms of maturation. In constant watch, our technical and sales team remains at your disposal and available for personalized bending, toasting, accessories, tests, etc. All tests are allowed! Every week, no less than 250 barrels come out of the Couchey cooperage workshop ●

ORIGIN	TYPE OF GRAIN	PROFILE	GRAPE VARIETIES	AGEING PERIODS	TOASTING	EXPERT RANGE
--------	---------------	---------	-----------------	----------------	----------	--------------

GAMME EXPERT

Piano	Centre of France house blend	Tight and medium-tight	Authentic, discreet oak impact, enhanced fruitiness	●	up to 10 months	ML	28 57 114 225 228 265 300 350 400 500 600
Allegro	Centre of France house blend	Tight and medium-tight	Round and sweet	●	up to 10 months	M+	28 57 114 225 228 265 300 350 400 500 600
Forte	Centre of France house blend	Tight and medium-tight	Empyreumatic aromas, toasted bread, coffee - Mocha	●	up to 10 months	F	28 57 114 225 228 265 300 350 400 500 600

TRADITIONAL RANGE

HBC	Centre of France house blend	Tight and medium-tight	Roundness, buttery mouthfeel- fatty expression, complex, touch of vanilla	● ●	11 to 18 months	L LC ML M+ F	225 228 265 300
HBE	East of France house blend	Tight and medium-tight	Reinforced tannic structure, oak impact	● ●	11 to 18 months	L LC ML M+ F	225 228 265 300
HB	All of France house blend	Tight and medium-tight	Ideal balance between oak impact and structure	● ●	11 to 18 months	L LC ML M+ F	28 57 114 225 228 265 300 350 400 500 600

CONFIDENTIAL RANGE

Tronçais	Centre of France (Allier)	Tight and medium-tight	Round, opulent, generous	● ●	11 to 18 months	L LC ML M+ F	228
Bertranges	Centre of France (Nièvre)	Tight and medium-tight	Balanced, elegance, sustained	●	11 to 18 months	L LC ML M+ F	228
Châtillon	Centre of France (Côte-d'Or)	Tight and medium-tight	Structured, robust, vigorous	● ●	11 to 18 months	L LC ML M+ F	228
Hexagone Série	Please check this year's Hexagone barrel	Tight and medium-tight	Depending on the oak Selection		Depending on the origin of oak	L LC ML M+ F	228

EXCEPTIONAL RANGE

Vidéo	Centre of France house blend	Extra-tight	Authentic, discreet oak impact, texture, long after taste, enhanced fruitiness	● ●	11 months and more, up to 24 months	ML	225 228 265 300 350 400 500 600
Alto	Centre of France house blend	Extra-tight	Rich, deep, unctuous and lightly toasted	●	11 months and more, up to 24 months	M+	225 228 265 300 350 400 500 600
HB36	All of France house blend 36 months drying time	Tight and medium-tight	Elegance, discreet, enhanced fruitiness	● ●	11 to 18 months	L LC ML M+ F	225 228 265 300 350 400 500 600

ABROAD RANGE

US OAK	US oak	Medium and tight	Aromatic, vanilla, coconut	● ●	11 to 18 months	L LC ML M+ F	228 500
Acacia	France	Medium and tight	Subtle, fine texture, white flowers notes, freshness	●	up to 10 months	L LC ML M+ F	228 500
Eastern European	Eastern European Oak	Tight and medium-tight	Rustic, pepper, spice	● ●	11 to 18 months	L LC ML M+ F	228 500

GRAPE VARIETY

● red

● white

This entire range can also be used on beers and spirits.

TOASTINGS AND AROMAS

L Low intensity and short toasting. Fresh oak characters, and elegant hints of bitterness for a maximum of dynamism.

LC The ideal compromise between our Light and Medium Long toasting regimen. An « al dente » toasting, without vegetal and wood notes, to provide as much freshness and dynamism as possible.

ML Deep extraction. The barrel spends more time on the toasting station, a moderate flame fosters a slower and deeper extraction. Develops fruit and flower aromas.

M+ A more intense toasting level: the toasting is shorter, but with more intense flames. Develops dark chocolate, mocha, toasted aromas.

F Intense toasting, stronger oak impact. Deep roasted toasty aromas.

🔥 Possibility of developing your own Toasting, consult us.

BENDING

🌀 Bending: classic fire, option steam bending contact us.



EXPERT RANGE

THE EXPERT RANGE

The Expert Range is characterized by an unique seasoning of woods, and a special toasting developed for these barrels, in order to create moderate oak impact, and a quick integration wine / oak. Perfect for short maturation, between 6 and 10 months. We make our own selection of wood (French oak) for this range.

Le Piano[®], l'Allegro[®] et le Forte[®] barrels were introduced in 2004 and have been successful in French and international wineries since then!

In brief...

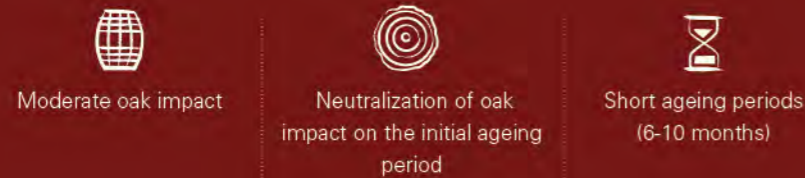





EXPERT RANGE
Centre of France
House blend



Volumes available: see pages 12-13





Piano[®]

A barrel developed for white grapes varieties, Piano[®] underlines the fruit, brings freshness, while respecting the typicity of grapes and the soil. Unquestionably the more discreet of the range !

-  White grape varieties and red fruity wines
-  Fruit, freshness, soil typicity
-  ML toasting
-  For wine ageing periods of up to 10 months

Allegro[®]

Allegro[®] is recommended for red grapes varieties, it brings more depth, a few toasted aromas, and car-amel sweetness for rounder wines.

-  Red grape varieties
-  Light toasted aromas, sweetness, roundness
-  M+ toasting
-  For wine ageing periods of up to 10 months

Forte[®]

Forte[®] is characterized by stronger wood impact, and coffee, toasted aromas. A barrel for those who are looking for oak tannins, recommended on red grapes varieties for wine ageing periods of up to 10 months.

-  Red grape varieties
-  Important oak impact
-  HT toasting
-  For wine ageing periods of up to 10 months



TRADITIONAL RANGE

TRADITIONAL RANGE



The Traditional Range has been the traditional barrel range created by Tonnellerie Rousseau! Started at the end of the 90's, tested and approved since then, it really symbolizes our experience and know-how.

It's been developed originally with Burgundian winemakers. Our goal was clearly to bring more consistency in the oak and toasting profiles.

Beyond a single forest, we have thus identified several regions of forests to offer similar products to our customers year after year.

The barrels can also be **easily customized**, since the level of toasting can be chosen among the 5 toasting levels we offer. Consequently, each barrel can be used for white or red wines.

In brief...

- 
 Consistency in oak profile
- 
 Level of toasting can be customized
- 
 Long ageing periods (12-15 months)

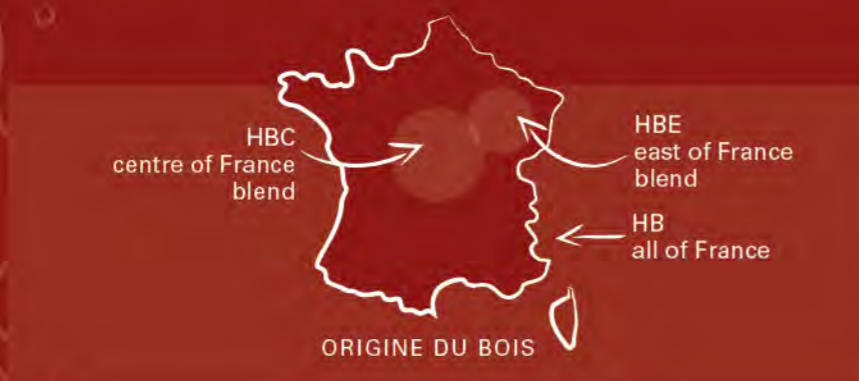



Volumes available: see pages 12-13

HBC / Centre of France blend

Our HBC barrel is made with oak from the Centre of France (Allier and surrounding forests), that brings up round aromas: **vanilla, chestnuts, almonds...**

The natural overall sweetness of the oaks of the Centre of France, and their notes of **vanilla** first found success with the top-quality Cognac brandies, and, for the last 30 years, with wines all around the world.

 White and red grape varieties

 Butter and vanilla aromas, round and full bodied

 5 toasting levels available: L, LC, ML, M+, HT

 For wine ageing periods between 11 and 18 months

HBE / East of France blend

The oaks of the East of France (Vosges and surroundings) grow slowly due to harsh weather conditions. The hilly countryside, in the foothills of the mountain, **creates very tight wood grains**. Our HBE barrel will give **more structured, focused, vibrant results to your wines – the exact opposite of the vanilla aromas provided by HBC.**

 White and red grape varieties

 Fresh wood aromas, reinforced tannic structure

 5 toasting levels available: L, LC, ML, M+, Forte

 For wine ageing periods between 11 and 18 months

HB / All of France

Each region has its characteristics and brings something different to the wine. The HB barrel is balanced and is the perfect synthesis between HBC and HBE: **the proper mix between wood impact and structure**. An adaptable barrel that will work with most of wines, a genuine and traditional approach of the French oak barrel.

 White and red grape varieties

 Balance, fine tannins, mixed oak character

 5 toasting levels available: L, LC, ML, M+, Forte

 For wine ageing periods between 11 and 18 months

CONFIDENTIAL RANGE

CONFIDENTIAL
RANGE

CONFIDENTIAL SERIES

1 barrel = 1 specific forest !

Our Confidential range brings to light the oaks grown in the state-owned forests of Tronçais, Bertranges, and Châtillon... These names evoke the most prestigious oak forests of France, and perhaps Europe!

We have set up a special supply chain for these barrels, in order to guarantee their origin.

Due to the scarcity of oaks, the barrels of our Confidential Range are only available in limited amounts and in 228 L.

In brief...



One specific forest



Choose your toasting level



Recommended on long ageing periods (11-18 months)

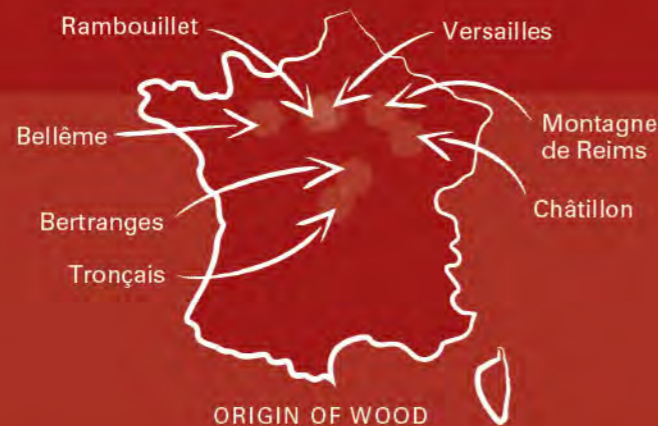

Volumes available: see pages 12-13

Tronçais

The Tronçais forest is in the heart of the Allier area, and counts more than 11 000 hectares of mainly high-quality oak trees, and around 40 springs. In 1670 Colbert, King Louis XIV's Finance Minister, decided to rehabilitate the forest to provide oak for the navy's ships. Since then, the Tronçais oak trees have been appreciated for their polysaccharides, and for developing a natural buttery and creamy expression, and light vanilla notes.



White and red grape varieties



Buttery and creamy expression, light vanilla notes, strength and elegance. Fine and soft tannins. Precision



5 toasting available: L, LC, ML, M+, Forte



Ageing periods of 11 to 18 months

Bertranges

The Forest of Bertranges covers 10 000 hectares and is one of the greatest French forests. Offered to the Priory of la Charité-sur-Loire in 1121, its size has been increased a number of times before becoming state owned at the time of the Revolution. Thanks to the soils that hold lots of water and minerals, the Bertanges oaks are elegant in character with a delicate tannic structure.



Red grape varieties



Elegance, nobility, length



5 toasting levels available: L, LC, ML, M+, Forte



Ageing periods of 11 to 18 months

Châtillon

The « Burgundy Mountains » (300 m high) offer a harsh climate to century old oaks, inexorably destined to a very slow growth rate. Châtillon represents the spirit of Burgundy. Naturally rich in polyphenols, Châtillon oak trees express fresh oak and the noble tannins of oak, for an impact that remains intense and full of energy.



White and red grape varieties



Robust, vigorous, fresh oak, structure



5 toasting levels available: L, LC, ML, M+, Forte



Ageing periods of 11 to 18 months

Collection Hexagone



With the Hexagone Collection, we want to take you on a journey to discover the most prestigious forests in France, famous or exclusive.

Each year, we'll introduce a new barrel from a new forest, a barrel numbered and in limited edition, so you can introduce as an innovating and original tool into your winery.

A new prestigious vessel that will highlight the French forests terroirs and your wines! Due to the scarcity of the oaks chosen, the Hexagone barrels are only available in 228 L.

Please get in touch with your usual sales rep who will tell you all about the current / next barrel available.

Our Tour de France of the French forests started in 2018, with Rambouillet, followed by Bellême, Montagne de Reims, Versailles...

- Collectible barrels
- 228 L, exceptional and numbered barrels
- A new forest every year

EXCEPTIONAL SERIES

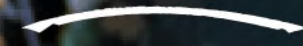

EXCEPTIONAL SERIES

You will find in our Exceptional Range our high-end barrels, recommended on your wines with great potential. Discover our special barrels: the famous Video®, our barrel with extra tight grain staves air-dried 30-36 months and Medium Long toast Alto, its big brother with a Medium Plus toast has joined the permanent range recently, and the classic HB36, with our France selection of staves air-dried for 36 months.

The existing quality of Rousseau's barrels, with improved grain tightness and seasoning.

In brief...



Extra-tight grains or long seasoning



For wine with high potential, high-end segment



Long ageing periods (11 months & more)

Volumes available: see pages 12-13

Video®

A tribute barrel to the 11 Best Craftsmen of France trained by the cooperage! Hand-picked extra-tight grain, a gold foil laid by hand on the top head, Video® represents our vision of cooperage: high-performance, elegance and precision



White and red grape varieties



Highlights the freshness of the fruit, reveals the typicity and character of each wine



ML toasting



Ageing periods: 11 months and more, up to 24 months

A Alto®

The Video® big brother, initially launched in 2015 in limited edition under the name « 60 », to celebrate the 60th anniversary of the cooperage. Largely appreciated on our French and export markets, we have decided to integrate it in our Exceptional range, renaming it Alto. Just like Video®, Alto is made with extra-tight grains. Recommended for structured wines, it will add volume and character to your grapes.



Red grape varieties



Complex woody impact, deep structure. Adds texture, without hiding the fruit



M+ toasting



Ageing periods: 11 months and more, up to 24 months

HB36

A French oak blend that has dried for 36 months. A long seasoning enables long, natural stabilisation of the staves for a more subtle oak impact.



White and red grape varieties



Lightness, length and tension



5 toasting levels available: L, LC, ML, M+, Forte



Ageing periods of 11 to 18 months



 Tonnellerie
ROUSSEAU

OUTSIDE FRANCE SERIES



OUTSIDE FRANCE SERIES

Even though, French oak was Rousseau's main focus for many years, the Burgundian cooperage started sourcing staves from 3 "exotic" species with very distinct aromatic profiles, to bring originality to the cellar.

In brief...



American oak, Acacia,
Eastern European oak



Choose your
toasting level



Recommended on short
and long ageing periods
(8-24 months)

Available volumes: see pages 12-13

American oak

This barrel is crafted in Burgundy for customers wishing to amplify the rich and vanilla aromas. American oak is endowed with a **great aromatic richness and texture**, it will bring moderate tannins and a nice volume to the wine, however, it should be used with care to prevent its aromas from taking over.



White and red grape varieties



Powerful notes of coconut, vanilla.
Creamy texture



5 toasting levels available: L, LC,
ML, M+, Forte



Ageing periods of 10 months and
more

Acacia

The acacia barrel is characterized by the absence of vanilla and dried fruit aromas. It is interesting and original for its **delicate, mineral and herbaceousness, and for the unparalleled floral note it will bring to your white wines. Note, however, that it will not have the same complexity as an oak barrel.**



White grape varieties



Delicate and mineral woody,
aromatic with notes of white
flowers, low structure



5 toasting levels available: L, LC,
ML, M+, Forte



Ageing periods of 6 months and
more

Eastern European oak

The Eastern European oak, with its very tight grain, will have a **limited aromatic contribution, bringing spicy and peppery notes and a structuring and lively contribution.**



White and red grape varieties



Structuring, aromatic, peppery, spicy
notes



5 toasting levels available: L, LC,
ML, M+, Forte



Ageing periods of 10 to 18

OPTIONS AND CUSTOMIZATION OF BARRELS



Custom barrels

Possibility of making your barrels with your oak staves, seasoned on your behalf in our wood yard. Once we agree on a seasoning regimen (24-36 months), it could be manufactured in our cooperage



Fermentation

If you want to make your winemaking in barrels, we offer different options:

- Installation of vinification bung on the head, and a racking valve
- Installation of a cupola lid positioned on the bung stave, and of a racking valve
- Wheel or ball bearing stand
- Possibility of delivery of an opened barrel for fermentation (head delivered to the side)
- Various bungs

> VOLUMES AVAILABLE: from 500 L



Laser etching of your logo

Your logo can be laser-etched on your barrels. This option is offered with any order.

> AVAILABILITY: all barrels



Special hoops

We offer, on all barrels, **galvanized hoops or painted in black or in the color of your choice**. We also offer **chestnut hoops** known as «bâtard» (4 chestnut circles) or «tradition» (8 chestnut circles) and the option with traditional hoops with reconditioned hoops on all 228 L.

> AVAILABILITY: **Black hoops: available for all barrels**
4 or 8 chestnut hoops: 228 L



Oak stands for barrels

Ideal to create a pyramid of barrels, or simply to move them more easily with a pallet jack or a forklift, our oak stands are **available for barrels from 228L to 600L**.

Please ask for the catalogue.

> AVAILABILITY : Available from 228 to 600 L



Barrels with glass display heads

This barrel will bring your wines all the qualities you are looking for when maturing in oak barrels, but it will also bring the fun factor into your winery.

For a maximum strength and visibility, we chose to use 8mm thick tempered glass.

> AVAILABILITY: from 225 L to 600 L



Oak Cross bar

To identify a cuvée or a batch, with a personalized oak plate placed on the bottom of your barrels and reusable for each vintage. Custom laser marking.

> AVAILABILITY: from 225 to 600 L

BARRELS DIMENSIONS

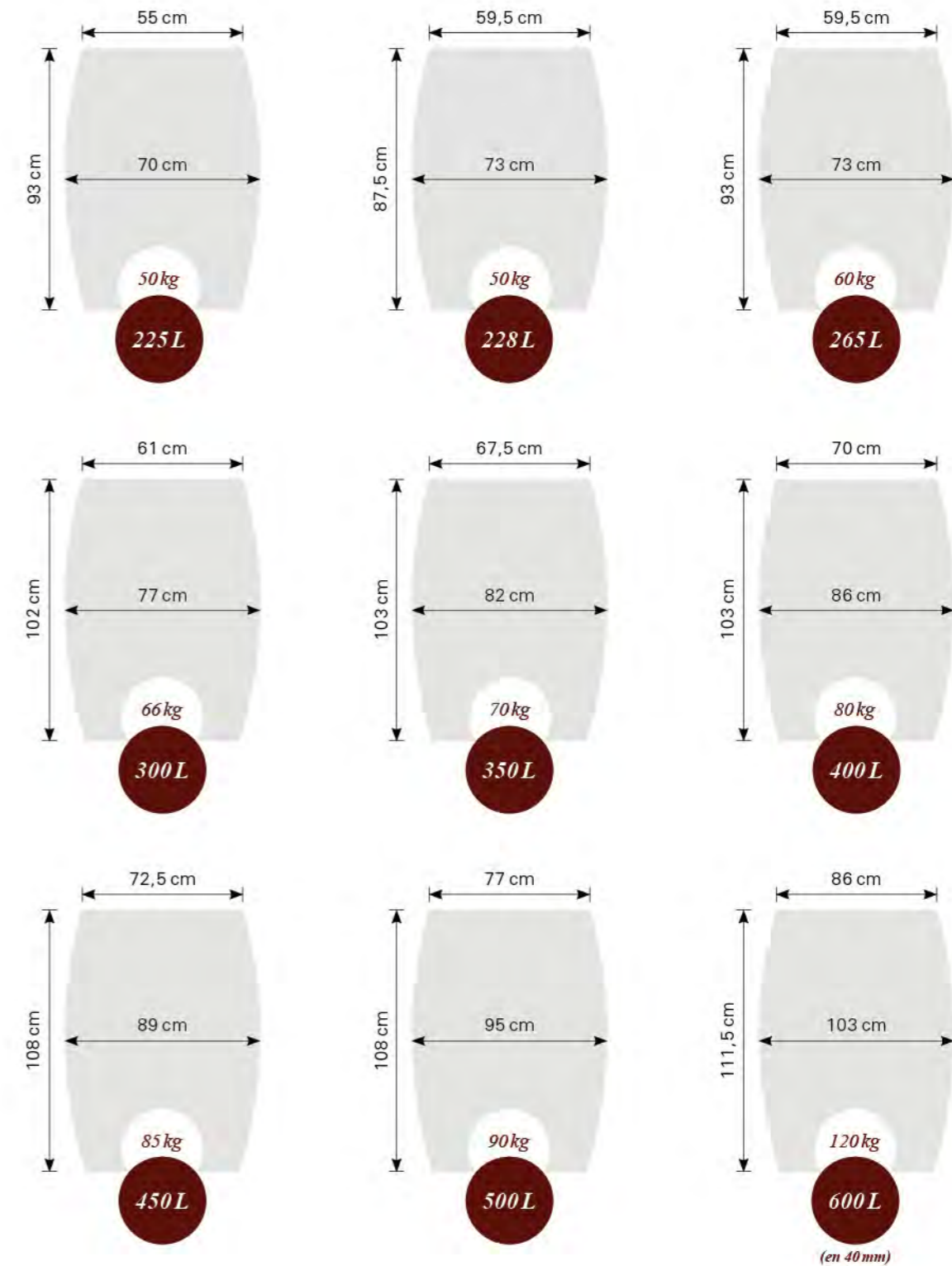

BARRELS STAND

Type of stand

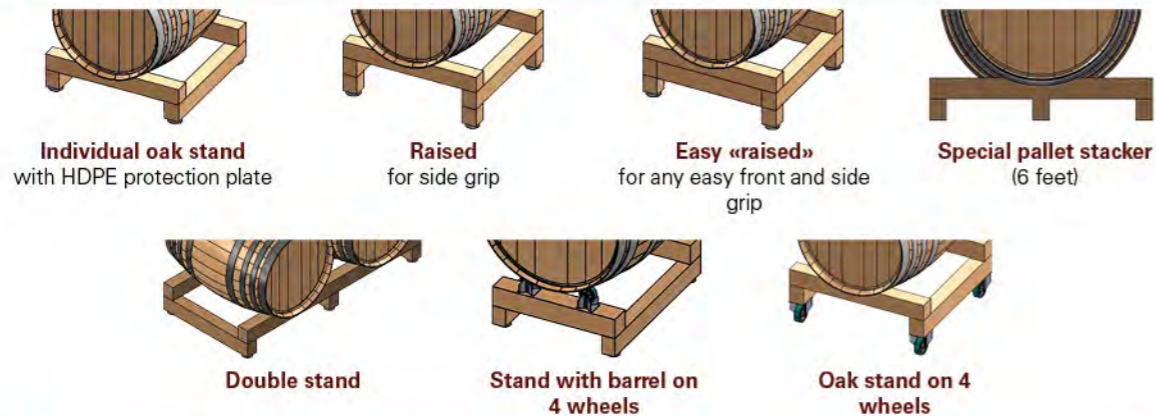

Dimensions of individual oak stands

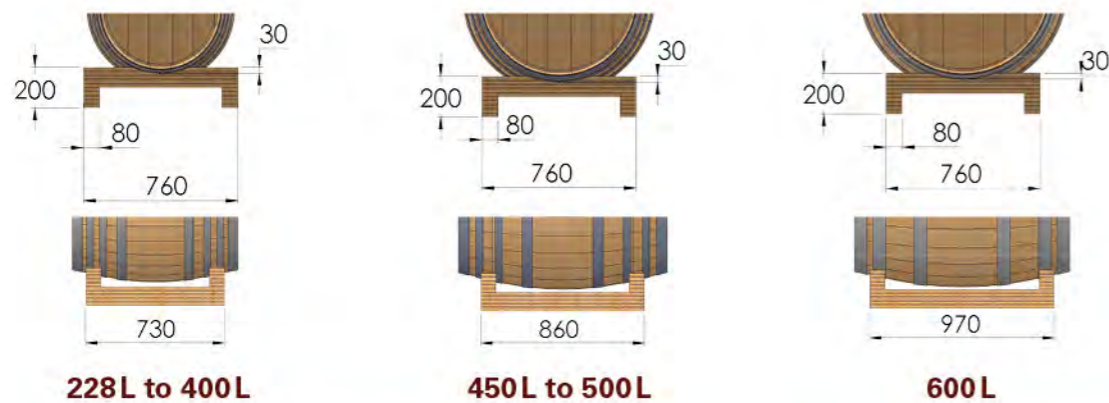

Cross bar for stacking

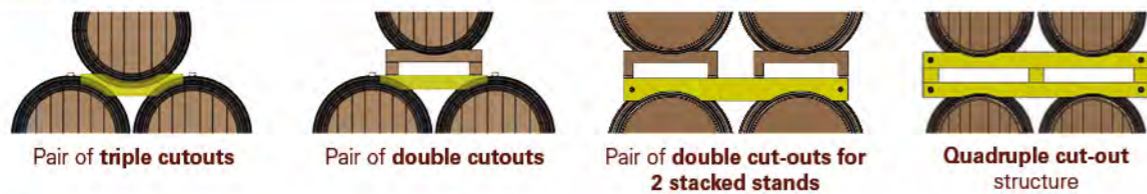

Oak beam

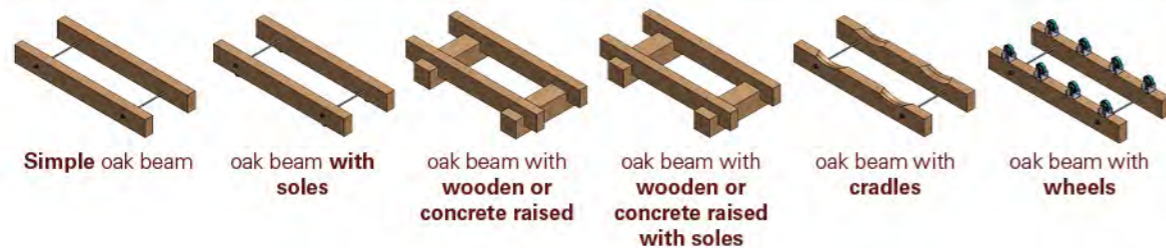

BARREL USER ADVICE

COMMISSIONING & MAINTENANCE OF BARRELS



If a leak appears, fill the barrel full of water and leave until the leak is plugged.
Caution: Do not leave the barrel full of water for longer than 24h. Empty the barrel and rinse with fresh water before leaving to drain.

PROLONGED STORAGE OF NEW BARRELS



- 1 Leave the barrels with their **protective plastic covering**.
- 2 Store barrels in an environment conforming to the following specifications

 Humidity: around 75-85%

 No air currents

 Low light

 Cover exposed parts to protect against UV



As a general rule, to maintain barrel quality, we recommend storing empty barrels in a cool, humid environment, away from sunlight and contact with air.

LARGE FORMATS WORKSHOP



THE LARGE FORMATS WORKSHOP IN GEVREY CHAMBERTIN



Since 2015, the large containers workshop has been in Gevrey-Chambertin.



Eco-responsible building: privileged natural light, intelligent vacuum system, ecological materials, etc.



1800m² of surface area, including 1500m² of workshop



More working comfort for the teams: reduction of arduousness, showers and rest rooms

THIS NEW WORKSHOP IS MADE UP OF 3 AREAS:



Manufacturing



Transformation and storage of ready-to-use raw material



Storage platform



NEW MACHINE

At the forefront of technology, Tonnellerie Rousseau, in collaboration with a French industrial design company, developed in 2021 a multi-module robot capable of scanning, sanding, vacuuming dust, and to adapt to all shapes and sizes of large formats, and which today makes it possible to reduce the strenuousness of the work in the workshop.

TAYLOR-MADE CRAFT

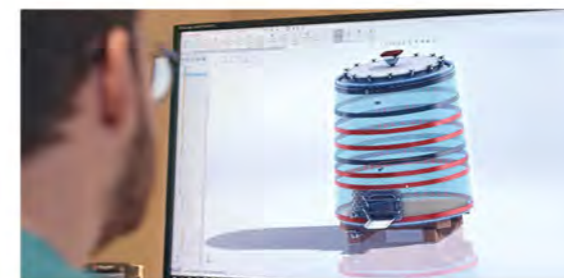

The Foudrerie workshop of Gevrey-Chambertin works closely with you to match your large format wine programs. Our integrated design office designs your project according to your architectural constraints (vaulted cellar, limited access) or technical (technical needs or search for working comfort).

Each Tanks or Casks project is unique !

We really reflect carefully on your cellar or tank configuration with an attentive project study whether it is a cask pyramid or several tanks installation with the cooperage's full support from the study of the project until its realization, its installation and even the after sales service.



Our team intervenes **from the project of the winery stage.**



Rousseau will **imagine with you and draw the perfect tank room** (vessel shape, volume, oak stand, pyramid etc.).



We support you **until the delivery and assembly** of your large containers on site.



Our work does not stop there: we follow up year after year for the taste and technical aspects (adding accessories, logistics, etc.).



RESEARCH, DEVELOPMENT & INNOVATION

Research & Development is essential to the Rousseau large formats plant. It is because we are listening to you that our team innovates and evolves.

At Tonnellerie Rousseau, R&D has no borders. Even at a distance of 9,000 km, we find solutions to your problems! In a historic area of Napa Valley in California, we have optimized space by creating a tailor-made footbridge positioned on a series of 45 hl oval casks.



Innovative shapes and casks/tanks models such as the Rousseau's "egg" "Ove" cask.



NEW PRODUCT

HYBRID RANGE



The result of a cooper inspiration, our hybrid range allows you to combine the small volume of the barrel with **the robustness, longevity and practicality of a cask**. Given their thickness and long toasting time, these small casks will have a **low woody impact**, which is

very respectful on your wines.

Customizable, they can be accessorized at your convenience, like a barrel or like a cask (see list of options below).

NEW PRODUCT

FR360°

THE ROTATIVE CASK



FR360° is a French oak round cask, customizable with your selection of accessories and positioned on a special oak stand with bearings.

The stand has been designed for casks up to 12HL. It is equipped with stainless steel bearings to facilitate the swinging and rotative movements. Thanks to this discrete and efficient system, it only takes one person to effortlessly make the cask rotate 360°.

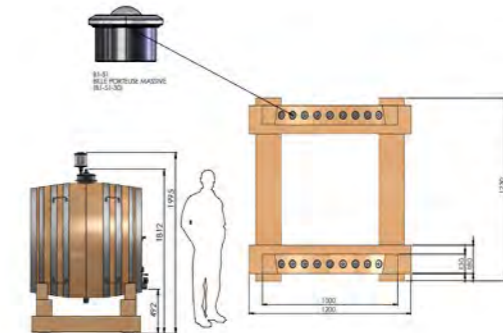

NEW PRODUCT

INOAK VAT

UNION OF AN OAK TANK AND A STAINLESS-STEEL TANK WITH A WITH AIR FLOATING LID

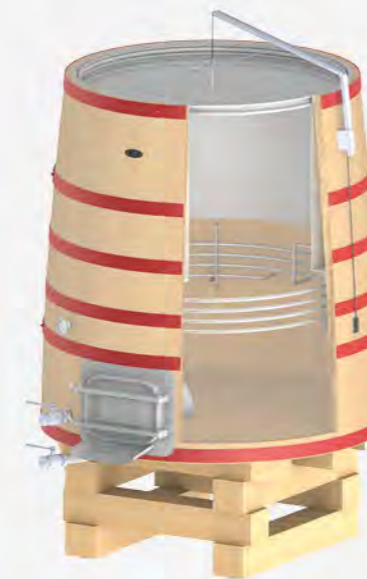

Flexibility of the floating lid, Technicality of the tapered tank and Authenticity of wood. Tonnellerie Rousseau is committed to innovating and providing aging and wine-making solutions to its customers. To respond to the problem of harvest variability and the need for flexibility of cellar containers, we propose a solution offering the volume adaptability of the floating lid while retaining the advantages of the oak tank. We have adapted this technical product by integrating it into the wooden vat for an authentic and warm aesthetic rendering.

The InOak tank is the successful marriage of performance, modernity and cooperage tradition !



To receive the complete technical sheets or for any questions concerning these 2 new products, do not hesitate to contact our sales team.



CUSTOMIZATION



1
SHAPE



2
DIMENSIONS / VOLUMES



3
ACCESSORIES



4
FINISHING

YOUR LARGE FORMAT IN 4 STEPS: SHAPE

CASKS

ROUND



OVAL



EGG-SHAPED



FOR ALL SHAPES

- > Multifunctional thanks to a wide range of accessories (vinification + aging)
- > French oak and controlled toasting for a better re-spect for the wine
- > Controlled oxygenation
- > Discreet oak impact thanks to controlled toasting and volume effect
- > **Positive financial impact** in the cost of ageing wines
- > Optimization of space
- > Improved cellar logistics
- > **Aesthetic** product in the cellar
- > Thermal inertia

SPÉCIFICITY OF CASKS

- > Quality of wood equivalent to stave quality for better reliability and product life

VATS

VINIFICATION VATS



VINIFICATION AND MATURATION VATS



SPECIFICITY OF THE TANKS

- > Fixation of the color by vinification in wood
- > Polymerization of tannins from fermentation
- > Temperature control
- > Immersion of the cap facilitated by the truncated shape

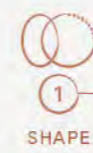

1
SHAPE



2
DIMENSIONS / VOLUMES

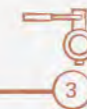

3
ACCESSORIES



4
FINISHING

YOUR LARGE FORMAT IN 4 STEPS: DIMENSIONS & VOLUMES

I HAVE A SPECIFIC VOLUME

We offer you the most practical volume for your organization: multiple of 5 hl, multiple of Burgundy barrel, multiple of the volume of your press...

"OVE" (EGG SHAPE) CASKS >> volume to choose, dimensions contact us.

ROUND CASKS

	CAPACITY (in hl)	LENGTH (in cm)	Ø BILGE (in cm)	Ø HEAD (in cm)
	10	126	126	114
C6	13,70	140	138	127
	15	142	142	131
	20	155	154	142
C10	22,80	164	160	146
	25	166	166	152
	30	176	175	160
C15	34,20	184	182	166
	35	184	184	168
	40	192	192	175
C20	45,60	202	199	181
	50	206	205	187
	55	212	212	193
C25	57,00	214	195	214
	60	218	219	201
	65	224	224	206
	70	230	229	210
	75	234	235	216
	80	240	239	219

OVAL CASKS

	CAPACITY (in hl)	LENGTH (in cm)	BILGE HEIGHT (in cm)	BILGE WIDTH (in cm)	HEAD HEIGHT (in cm)	HEAD WIDTH (in cm)
	10	138	139	125	107	93
C08	13,70	164	150	134	112	100
	15	158	157	141	118	102
	20	172	173	155	129	111
C10	22,80	176	176	160	132	120
	25	184	183	164	139	120
	30	196	196	175	146	125
C15	34,20	200	201	183	151	137
	35	204	204	183	154	133
	40	212	213	191	161	139
C20	45,60	220	216	196	162	146
	50	228	228	204	172	148
	55	234	235	211	177	153
C25	57,00	236	232	212	174	159
	60	240	241	221	181	161
	65	248	248	227	186	165
	70	252	253	232	190	169
	75	258	259	237	194	172
	80	264	264	241	198	175

For casks of volumes of 60hl to 80hl: thickness of 60mm recommended.
>> Consult us.

VINIFICATION / MATURATION VAT

	CAPACITY (in hl)	STAVE LENGTH (in cm)	LOW DIAMETER (in cm)	TOP DIAMETER (in cm)
	10	126	126	104
1T	12,64	120	142	120
	15	142	142	119
	20	154	155	131
S10	22,60	160	164	142
2T	25,44	160	170	144
	30	176	176	151
S15	34,20	182	184	160
	35	184	183	158
3T	38,09	184	190	164
	40	192	191	166
S20	45,60	184	214	184
4T	50,97	188	214	188
	55	210	211	184
S25	57,00	206	220	194
	60	216	216	190
5T	63,37	218	220	194
	65			
S30	68,40	242	220	194
	70	226	227	200
6T	76,16	260	220	194
	80	236	237	209
7T	88,80	290	224	196
8T	101,49	330	224	196

I HAVE LIMITED SPACE, I NEED TO OPTIMIZE IT

- > We take **the measurements** of your cellar, door, elevator, winery ...
- > We study **your project**
- > We offer you **the shapes, volumes and dimensions** to optimize the space
- > We draw up **the product plan and a cellar layout plan** to occupy the space and we offer you a complete plan of your cellar.
- > Possibility to assemble **your large format on site.**



EXAMPLE: Constraint, technique and aesthetics: transformation of a courtyard into a cellar, use as much volume as possible while keeping the heads of the same size

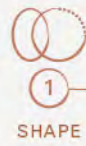

1
SHAPE



2
DIMENSIONS / VOLUMES



3
ACCESSORIES



4
FINISHING

YOUR LARGE FORMAT IN 4 STEPS: ACCESSORIES

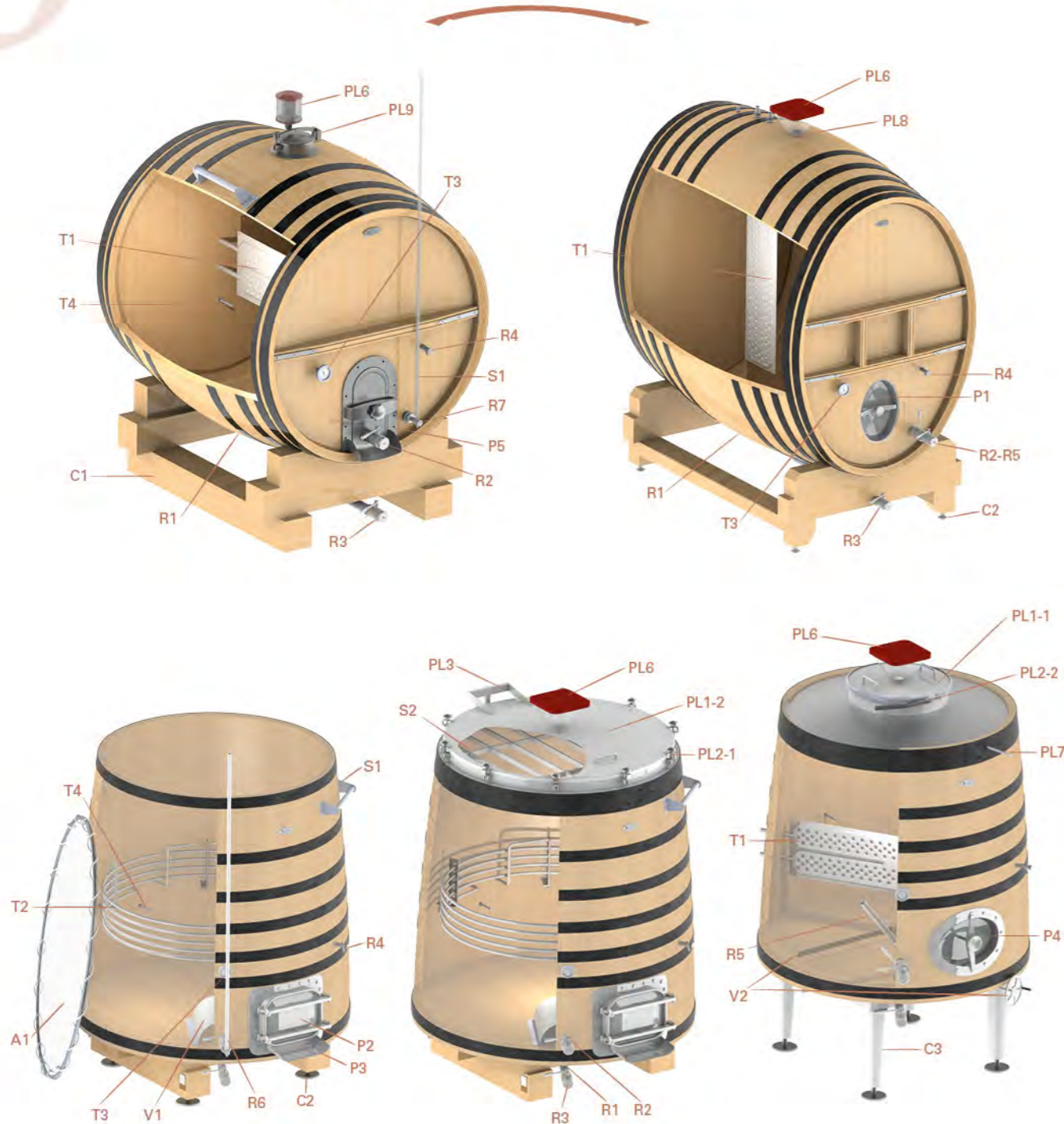

COMMON ACCESSORIES TO CASKS AND VATS

R STAINLESS STEEL TAPS

- R1 Draining port + plug*
- R2 Racking valve 40/50 - Mâcon / DIN / Clamp...*
- R3 Tube + draining valve 40/50 - Mâcon / DIN / Clamp...*
- R4 Taster + extension: classic, with key, Equinox*
- R5 Arm-taste lees
- R6 Fixed level valve with tube (optional stainless-steel rule)
- R7 Gauge glass (SS ruler optional)

PL BUNG

- PL6 Bung: silicone, Bellot VOG*, siphoid

T TEMPERATURE CONTROL

- T1 Heating / cooling panel
- T3 Thermometer
- T4 Thermowell

C STANDS

- C1 Oak Stand with SS plates*
- C2 Adjustable SS Plates
- C3 SS Stand

COMPLEMENTARY ACCESSORIES CASKS

P DOOR CASKS

- P1 Oval stainless steel cask door Horizontal or vertical*
- P5 Half-Round Stainless Steel Door

PL LID AND BUNG CASKS

- PL8 Stainless steel bung seat*
- PL9 Cupola lid diam. 22cm

S SAFETY CASKS

- S1 Ladder rung

COMPLEMENTARY ACCESSORIES VATS

PL STAINLESS STEEL LID

- PL1-1 SS lid, diameter of your choice
- PL1-2 Fully opening Lid
- PL2-1 Micrometric closure system
- PL2-2 Clamp closure
- PL3 Hinges
- PL4 Stem (consult us)
- PL5 Stainless steel ring with floating lid (consult us)
- PL7 Anti-retention tube

V VINIFICATION VATS

- V1 Seed-screen
- V2 Lees stirring device

T TEMPERATURE CONTROL VATS

- T2 Serpentine - See common options

P DOOR VATS

- P2 SS door high position or Flush-mounted SS
- P3 Lip on rectangular door
- P4 Oval Stainless-Steel Door

S SECURITY VATS

- S1 Ladder hook
- S2 Protection grid/guard

A ACCESSORIES VARIOUS VATS

- A1 Cover Vinification vats

*Accessories included in the series C and CO

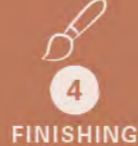
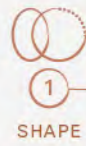

YOUR LARGE FORMAT IN 4 STEPS: FINISHING

OAK STANDS

Oak or stainless steel stand, with fix or adjustable SS protections plates, personalized shape...



• Oak • standard stand double side grip



• Oak • adjustable SS protection plates • classical Rousseau shape



• Oak • raised stand • SS protection plates



• SS stand • adjustable feet



• SS stand with special forklift pockets



• Cradle with stone stand (please contact us)

STRUCTURE

Stainless steel structure



Pyramidal Oak Structure



FINISHING

Non varnished



Varnish



Linseed oil



LOGO

Laser marking
(casks only)



On oak plate

directly on Head (casks <30hl)

Sticker



Metal plate
(on cask and vats)



(cost, contact us)

COLOR OF HOOPS

Galvanized without paint



Stainless steel



Painted in black



Other color of your choice





TURNKEY

LARGE VESSELS TURNKEY

A large format with the most commonly used accessories depending on your use: vinification or aging

AGEING IN CASK

Round Casks: reference **C** - **Oval casks:** reference **CO**
Volumes corresponding to multiples of 228 l



Barrels References available:

ROUND CASK	OVAL CASK	VOLUME IN HL
C6	CO6	13,70
C10	CO10	22,80
C15	CO15	34,20
C20	CO20	45,60
C25	CO25	57

Accessories included:

Racking valve
Elbow and stainless-steel pipe + draining valve
Oval or half-round stainless-steel door
Tasting valve
Bellot «VOG 210» hydraulic bung

AGEING IN TANK

Maturation tank with top and accessories: reference **S**
Volumes corresponding to multiples of 228 l



References available:

TANK	VOLUME IN HL
S10	22,8
S15	34,2
S20	45,6
S25	57
S30	68,4

Accessories included:

Racking valve
Draining valve
600mm SS lid
Tasting valve
Bellot «VOG210» hydraulic bung

ALL OUR TURNKEY REFERENCES INCLUDE:



Oak stand with stainless steel protective feet (rings)



Painted circles



Cooper varnish



Customer logo marking



Possibility of adding accessories

>> see accessories p48

VINIFICATION IN OPEN VAT

Vinification vats - Open, no lid: reference **T**
Volumes corresponding to multiples of 12.64 hl (1 Ton of harvest)



References available:

TANK	VOLUME IN HL
1T	12,64
2T	25,44
3T	38,09
4T	50,97
5T	63,37
6T	76,16
7T	88,8
8T	101,49

Accessories included:

Racking valve
Conical port (draining) from 4T

VINIFICATION AND MATURATION IN TANK

Vinification / maturation vat with top and accessories: reference **ST**
Volumes corresponding to multiples of 12.64 hl (1 Ton of harvest)



References available:

TANK	VOLUME IN HL
4ST	50,91
5ST	64,56
6ST	76,63
7ST	89,25
8ST	101,93

Accessories included:

Racking valve
Draining valve
Flush-mounted SS rectangular door + lip
Trappe de 1400mm
1400mm SS lid
Tasting valve

USER ADVICE AND MAINTENANCE FOR LARGE FORMATS

STORAGE

If you need to store the product prior to use, follow these guidelines in order to reach its full potential and avoid deterioration. Wood is a living material and hence, fragile.

A few precautions:

 **Do not remove the packing material** only do so when preparing for definitive use

 **Store at max** (20°C with humidity between 75-85 %).



Caution: Strong light can cause deterioration and premature drying.

If the storage area is too dry, water the ground to increase humidity.
Never store this product in a dry environment or outside

PREPARATION OF YOUR LARGE FORMAT

1 Seasoning

All our large formats are fully filled with water during 48h prior to shipment, nevertheless, **we advise you to fully fill the product with water, especially if it has been stored or shipped for long periods.** The process is called soaking up, it allows the wood to return to its initial state and stops any leakage. If you don't want to fill it with water, rinse thoroughly your large format before the first use. Only use clean, filtered water with no chlorine content. Do not let the water stagnate, and change it regularly during one week.

2 Rinsing Out

Use a soft brush. **Clean internal surfaces and rinse at low pressure** to eliminate impurities.

3 Draining

Once drained, the product is ready to be filled with wine.

REGULAR MAINTENANCE

Always keep maturation and ageing vats and casks full in order to prolong their useful life and avoid deterioration. Remaining empty for too long may alter their mechanical qualities and maturation and ageing potential. Refill immediately after a thorough cleaning is completed.

1 Draining

Once the tank/cask is empty, **rinse it with fresh water and repeat the cleaning process.** Drain.

2 Storing empty

If the product has to be stored empty for a few weeks, **keep at max. 68 F with humidity 75 - 85%.**

3 Drying

After washing and rinsing, **the product needs to be air-dried** (a fan can be used) This drying step is essential to maintain the vessel sanitized.

In the meantime, make a visual inspection (for mold) and an olfactory inspection. Repeat the maintenance process as often as necessary.



STEAM CLEANING:

While steam cleaning has benefits, precautions should be taken because its use can irreversibly damage your product:

No more than 1 minute per HL and 60 minutes maximum in all

Keep all valves, bung and door open during steaming

Do not close before the product has cooled down (risk of depressurization which would cause the staves, hoops and oak bottom to move)

Rinse with cold water and ventilate well before disinfecting with SO₂ gas or SO₂ solution and closing.

ADVICES FOR A CAREFUL DRYING

1
Open all taps, traps and doors to provide maximum ventilation.

2
Use fans to circulate the air inside. During several days if necessary. This avoids undesirable mold, a TCA/TCP precursor.

3
Close up carefully.

4
When completely dry, sanitize the vessel by burning sulphur pellets inside, using 2 g of sulphur/ hectolitre

5
sanitize the vessel on a regular, monthly basis.

Please check with your oenologist the amount of sulphur to be used.

EXTERNAL MAINTENANCE

 After two or three years, the hoops may need to be repainted and the staves revarnished.

 Large formats move in a workspace, they can be stained by wine. To remove a fresh stain, use a damp sponge, for an older dry stain, sand and apply cooper varnish.

 There is a risk of condensation on the stainless-steel doors and lids (which is normal), a simple wipe of the regular cloth can avoid staining the wood definitively.



We recommend using products specially designed for the food and drinks industry. Contact your local Tonnellerie Rousseau agent or representative for the product references, or their equivalent.

EVERYWHERE
**IN FRANCE &
INTERNATIONALLY**



Headquarters & Cooperage:

ZA de Champys
21160 Couchey
FRANCE

Large Formats Workshop:

Route de Saulon
21220 Gevrey-Chambertin
FRANCE

contact@tonnellerie-rousseau.com



Tonnellerie
ROUSSEAU

Let's combine our talents!

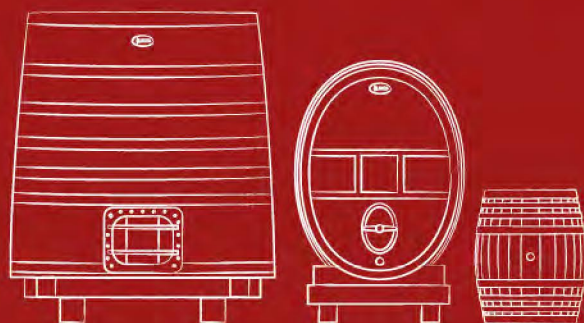

**Vitis &
Winemakers**

www.vitiswinemakers.com